

Bend – lockseamed

BFUSS 90°



Description

Segmented and lockseamed bend.

The product is CE marked according to EN 12101-7 and used in a circular smoke control system - single compartment (see declaration of performance).

Technical data

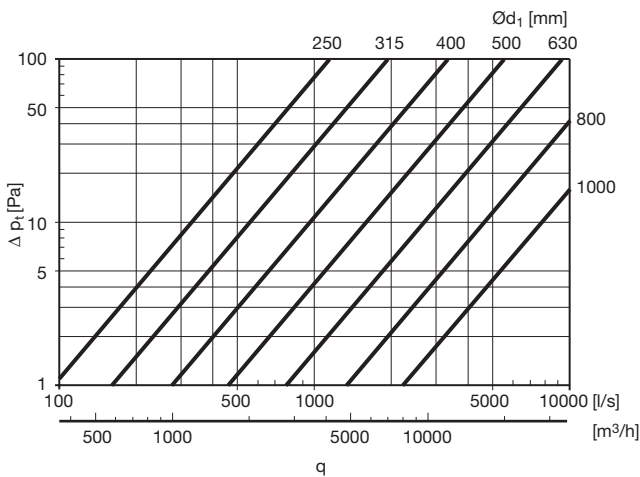

Dimensions

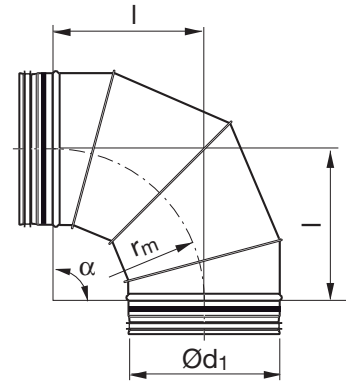

$$r_m \approx 1 \cdot d_1$$

$\text{Ø}d_1$ nom	l [mm]	m [kg]
200	200	1,60
250	250	2,20
280	280	2,50
300	300	2,7
315	315	3,00
355	355	3,75
400	400	5,64
450	450	7,00
500	500	8,20
560	560	10,1
600	600	11,7
630	630	12,9
710	710	19,8
800	800	26,0
900	900	33,6
1000	1000	42,0

Ordering example



Bend – lockseamed

BFUSS 60°



Description

Segmented and lockseamed bend.

The product is CE marked according to EN 12101-7 and used in a circular smoke control system - single compartment (see declaration of performance).

Technical data

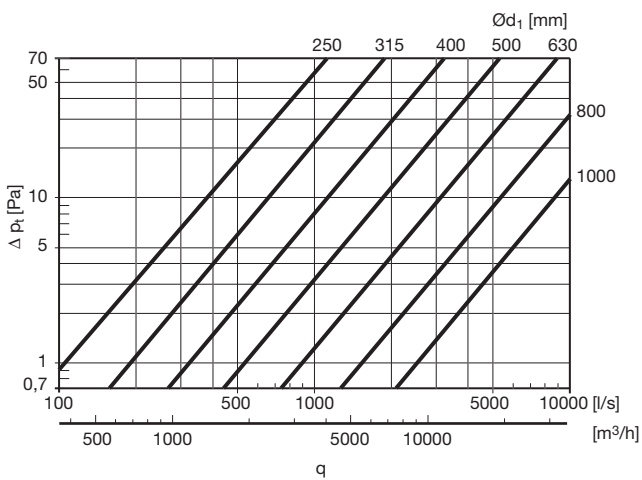

Dimensions

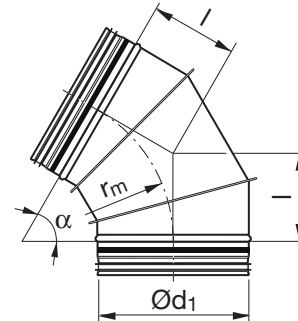

$$r_m \approx 1 \cdot d_1$$

Ød ₁ nom	l [mm]	m [kg]
250	144	1,48
280	162	1,80
300	173	2,00
315	182	2,20
355	205	2,80
400	231	3,47
450	260	4,70
500	289	6,00
560	323	7,40
600	346	8,60
630	364	9,20
710	410	11,3
800	462	14,8
900	520	19,3
1000	577	24,2

Bend – lockseamed

BFUSS 45°



Description

Segmented and lockseamed bend.

The product is CE marked according to EN 12101-7 and used in a circular smoke control system - single compartment (see declaration of performance).

Technical data

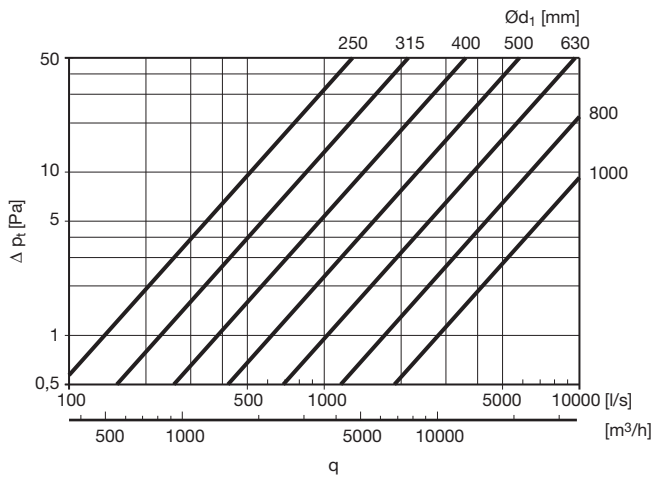

Dimensions

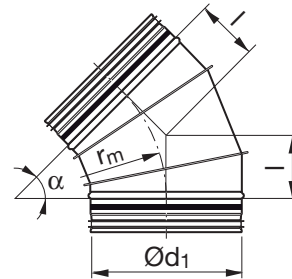

$$r_m = 1 \cdot d_1$$

Ød ₁ nom	l [mm]	m [kg]
200	83	0,9
224	93	1,2
250	104	1,26
280	116	1,54
300	124	1,77
315	130	1,90
355	147	2,26
400	166	2,96
450	186	4,00
500	207	4,90
560	232	6,10
600	249	6,80
630	261	7,49
710	294	11,3
800	331	15,0
900	373	16,8
1000	414	19,5

Bend – lockseamed

BFUSS 30°



Description

Segmented and lockseamed bend.

The product is CE marked according to EN 12101-7 and used in a circular smoke control system - single compartment (see declaration of performance).

Technical data

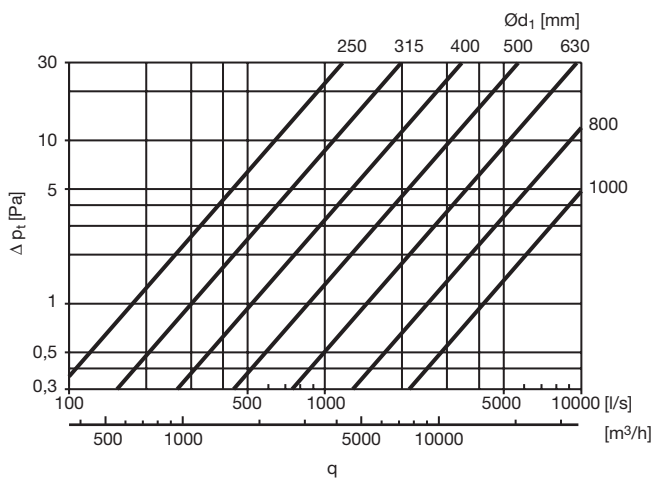

Dimensions

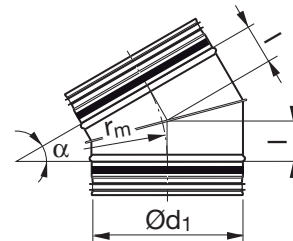

$$r_m = 1 \cdot d_1$$

Ød ₁ nom	l [mm]	m [kg]
200	55	0,5
224	58	0,7
250	67	1,00
280	75	1,10
300	80	1,30
315	84	1,42
355	95	1,70
400	107	2,27
450	121	3,00
500	134	3,70
560	150	4,60
600	161	5,10
630	169	5,60
710	190	8,60
800	214	11,0
900	241	10,9
1000	268	13,4

Bend – lockseamed

BFUSS 15°



Description

Segmented and lockseamed bend.

The product is CE marked according to EN 12101-7 and used in a circular smoke control system - single compartment (see declaration of performance).

Technical data

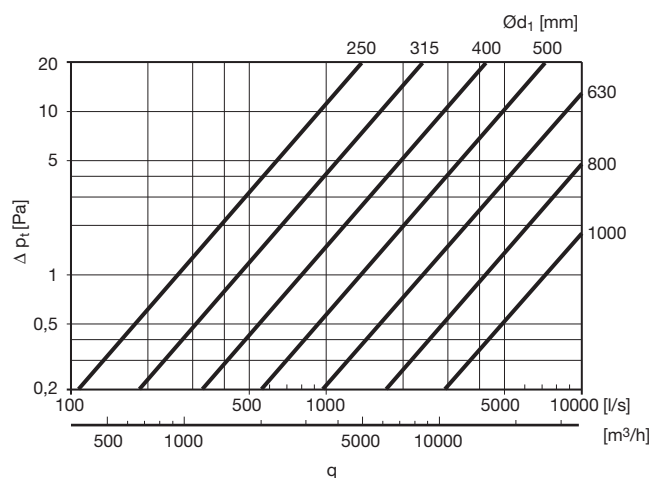

Dimensions

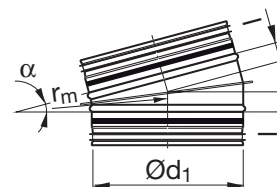

$$r_m = 1 \cdot d_1$$

Ød ₁ nom	l [mm]	m [kg]
200	40	0,5
224	43	0,7
250	33	0,65
280	37	0,77
300	39	0,85
315	41	0,91
355	47	1,41
400	53	1,70
450	59	2,20
500	66	2,65
560	74	3,30
600	79	3,70
630	83	4,00
710	93	5,80
800	105	7,00
900	118	8,50
1000	132	10,4