



Lindab **Professor XP**

Quick installations guide



Quick installations guide

Professor XP

Symbols



Hot water



Hand-pull



Cold water



Heavy Load - 2 man job - It is recommended to use a "lift" for mounting.

Tools



Knife



Gloves



Shoes with soft soles

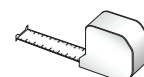

Tape measure

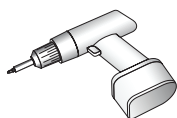

Drill machine

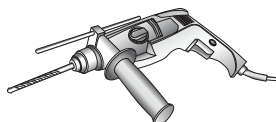

Percussion drill

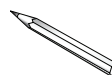

Pencil



Spanner

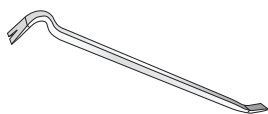

Crowbar

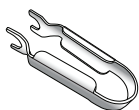

Tectite tool 12 mm
(Order no: 884087)



Tectite tool small 12 mm
(Order no: 646881)



Screwdriver

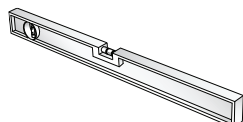

Spirit level



Lindab PC410
(Order no: 103344)

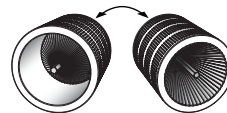

Deburring tool

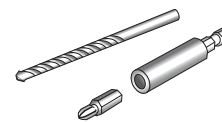

Bits and drills



Vacuum cleaner



Dust-cleaner

Quick installations guide

Professor XP

Packing and unpacking

! Never use water pipe connections for lifting.

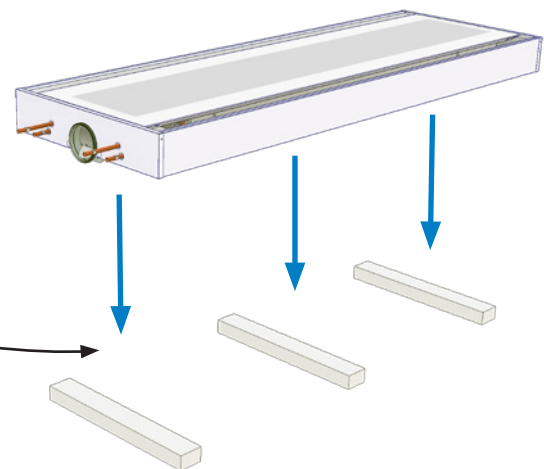
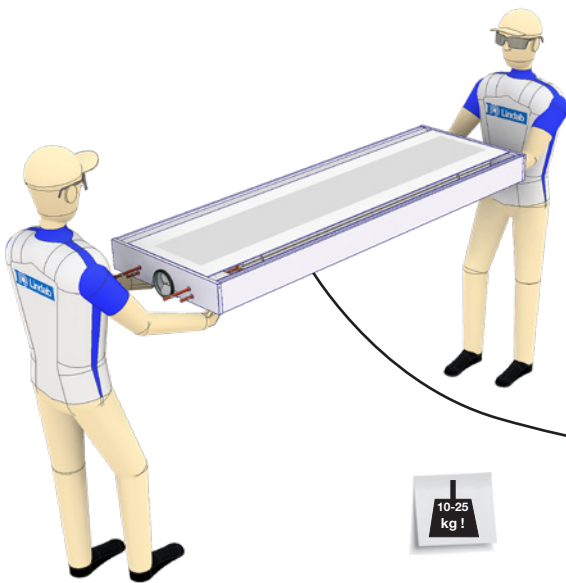
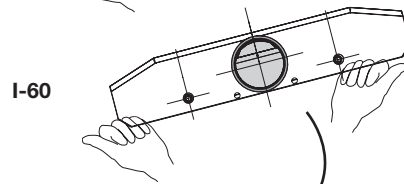
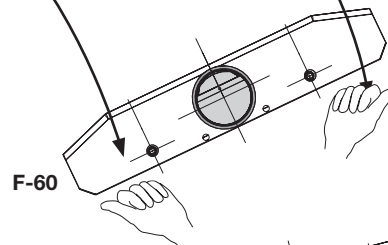

Quick installations guide

Professor XP

Order code label

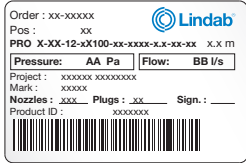

x2



Professor XP I-60

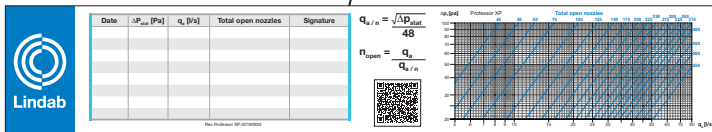

PRO	X-XX	12	Xx100	XX	XXXX	X.X	XX	XX
	I-45* I-60* F-45* F-60*	Ø12	1x100 2x100	A1 A2 A3 A4 B1 B2 B3 B4	0400 0600 0800 1200 0402 0602 0606 0802 0806 1202 1206	Nominal product length [m] 1.2 m - 3.6 m in steps of 0.1 m	Static nozzle pressure [Pa] 30-120 Pa	Primary air flow rate [l/s] 5-80 l/s

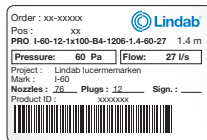
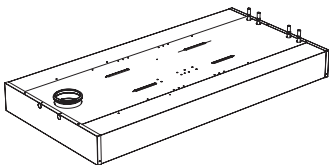

PRO - I - 60 - 12 - 1x100 - B4 - 1206 - 1.4 - 60 - 27

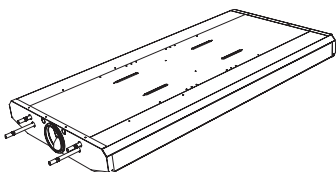

PRO - F - 60 - 12 - 1x100 - A1 - 0602 - 1.2 - 40 - 18

Quick installations guide

Professor XP

Material data

Material data

Type	Professor XP
Copper pipes, quality	EN-12735-2 CU-DHP
Pressure class	PN10

Specific measures for the water circuit

Performance value	Function	Battery type CC HH	Dry weight [kg/m]	Water content cooling [l/m]	Water content heating [l/m]	Water content total [l/m]
Maximal cooling and maximal heating	4-pipe	12 06	14.2	1.1	0.6	1.7
Maximal cooling and minimal heating	4-pipe	12 02	13.7	1.1	0.3	1.4
Maximal cooling or maximal heating	2-pipe	12 00	13.5	1.1		1.1
High cooling and maximal heating	4-pipe	08 06	13.7	0.8	0.6	1.4
High cooling and minimal heating	4-pipe	08 02	13.2	0.8	0.3	1.1
High cooling or high heating	2-pipe	08 00	13.0	0.8		0.8
Medium cooling and maximal heating	4-pipe	06 06	12.4	0.6	0.6	1.2
Medium cooling and minimal heating	4-pipe	06 02	11.9	0.6	0.3	0.9
Medium cooling or medium heating	2-pipe	06 00	11.6	0.6		0.6
Minimal cooling and minimal heating	4-pipe	04 02	11.8	0.4	0.3	0.7
Minimal cooling or minimal heating	2-pipe	04 00	11.5	0.4		0.4

Environmental Declarations

Please follow the links below

- [Building product declaration](#)
- [Declaration of conformity](#)
- [Eurovent certificate](#)

Pressure Class

The waterborne products in Lindab, active chilled beams (battery products), passive chilled beams (battery and strips products), facade units (battery) and radiant panels (strips and panels) are produced according to pressure class PN10 according to EN 1333: 2006.

This means the maximal working pressure for the products at a water temperature of 20°C must not exceed 10 bar.

Quick installations guide

Professor XP

Dimensions

F-60

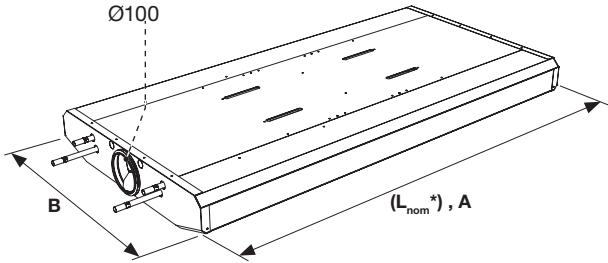

I-60

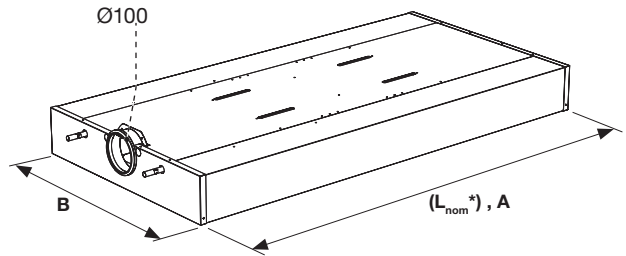

All water-pipes $\varnothing = 12$ mm, go to page 8.

F-models

F-45

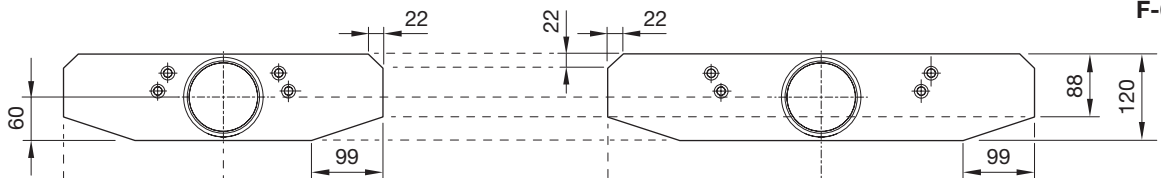

F-60

I-models

I-45

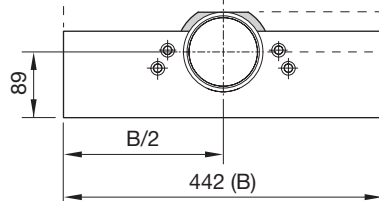

I-60

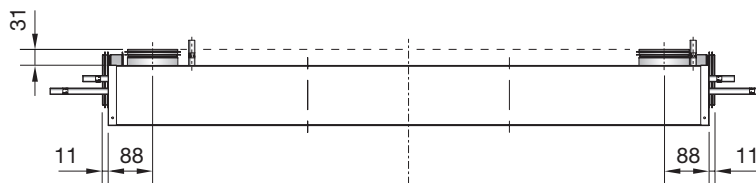
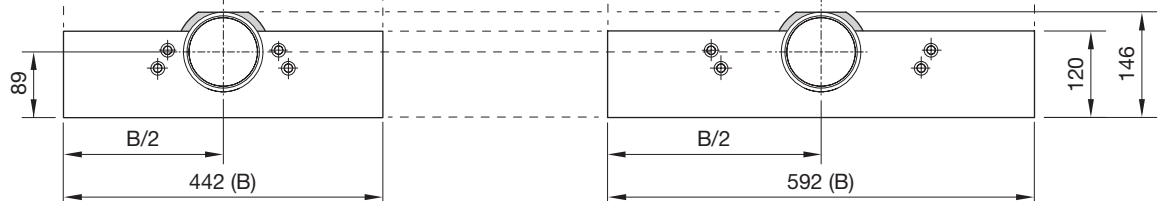

Professor XP	L_{nom}^* [mm]	A [mm]	B [mm]	[kg / m]	Ceiling type
F-45	1200, 1300 3500, 3600 In steps of 0.1 m	1192, 1292, 3492, 3592	442	Go to table on page 5	Exposed
I-45					1
F-60			592		Exposed
I-60					1

* L_{nom} = Nominal length (Order length).

Quick installations guide

Professor XP

Water connections

Professor XP water pipe dimensions and placement for F-models and I models.

The dimension for all water pipe connections are $\varnothing = 12$ mm.

F models

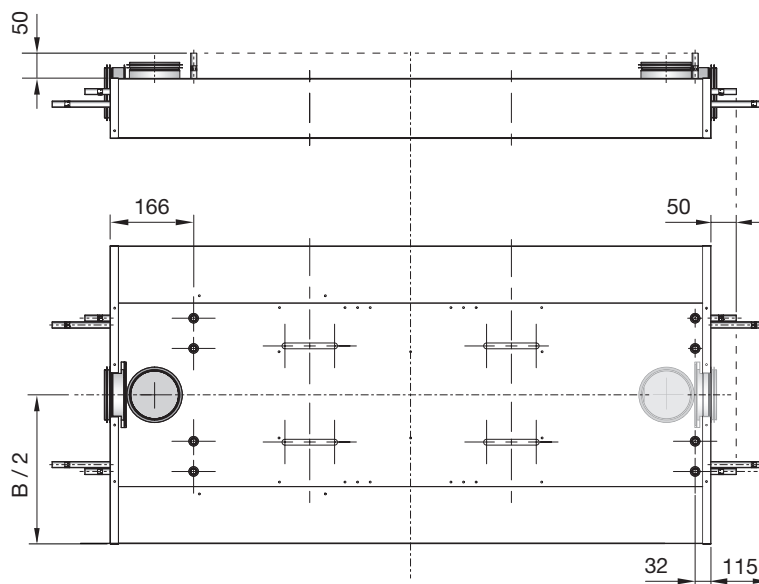
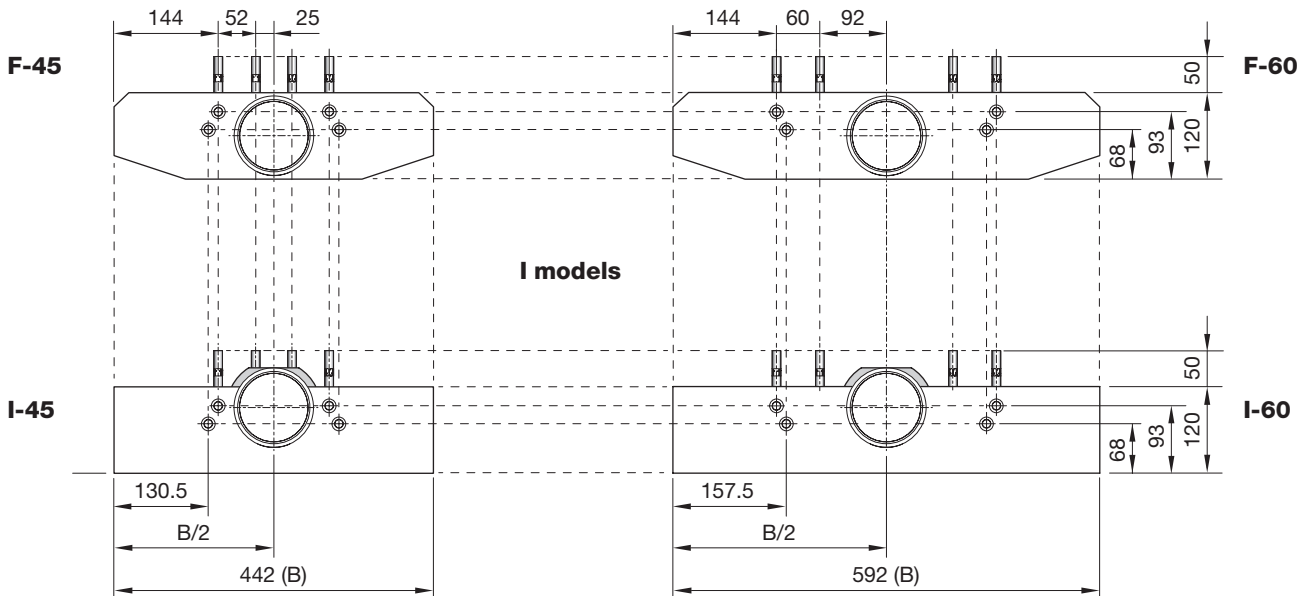

Quick installations guide

Professor XP

Water connections

Professor XP: F-45, F-60, I-45 and I-60 cooling or heating (2 pipe standard), I-62, J-60, K-60, L-60, X-60, Y-60 and Z-60 (ceiling adapted models).

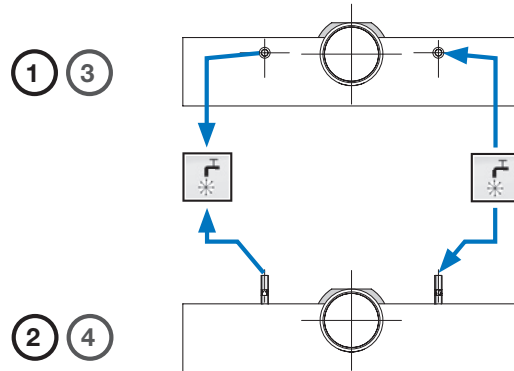
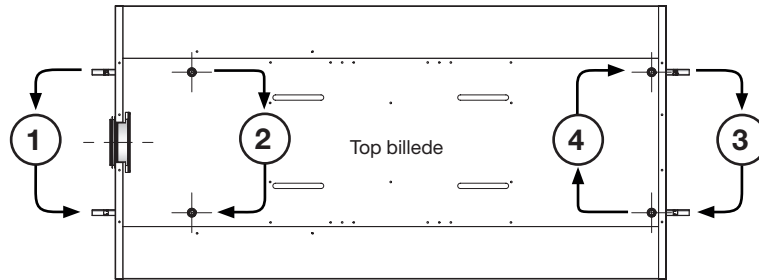

Professor XP: F-45, F-60, I-45 and I-60 cooling or heating (4 pipe standard), I-62, J-60, K-60, L-60, X-60, Y-60 and Z-60 (ceiling adapted models).

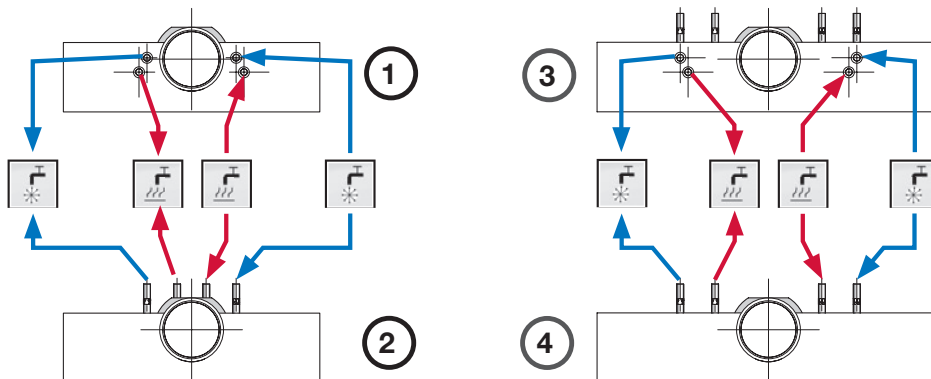
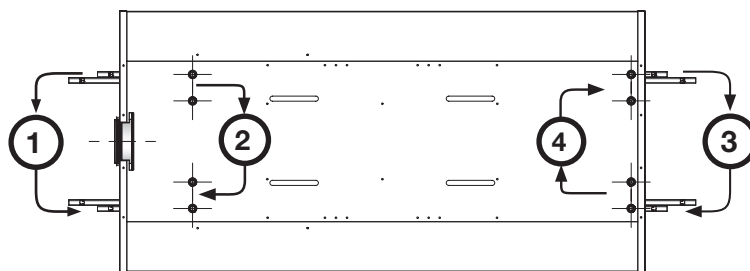

Quick installations guide

Professor XP

Regula components and valves

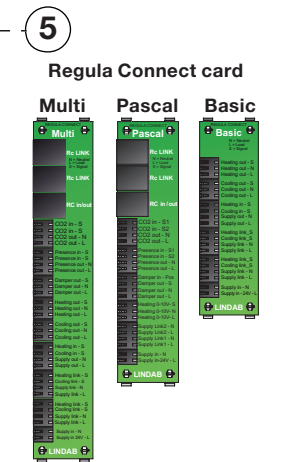
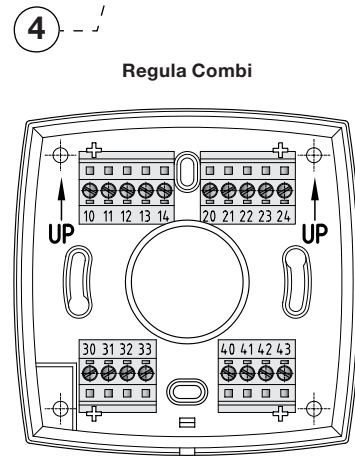
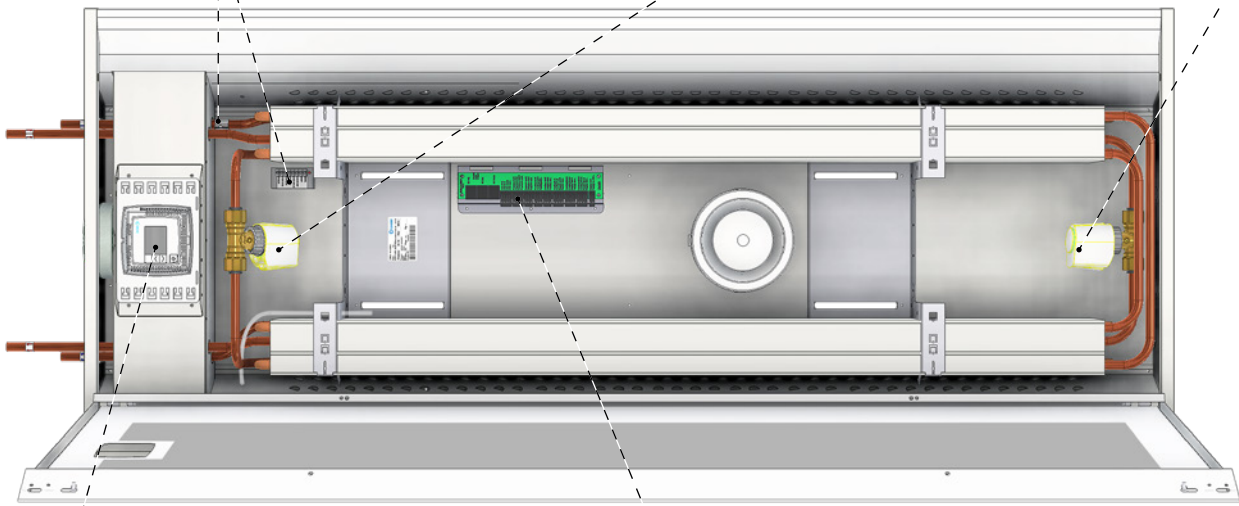
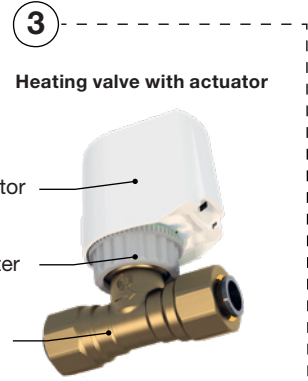
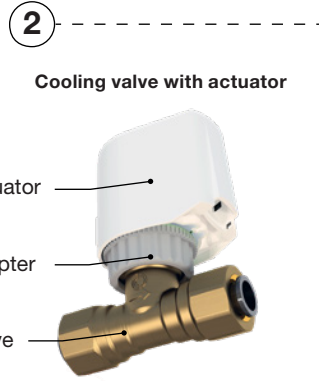
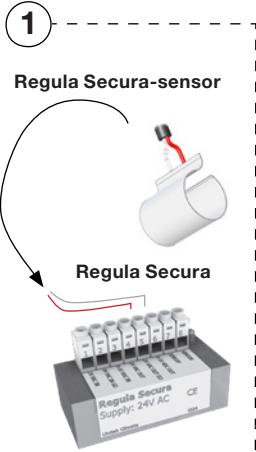

(with protection covers, optional).

Quick installations guide

Professor XP

Before installation

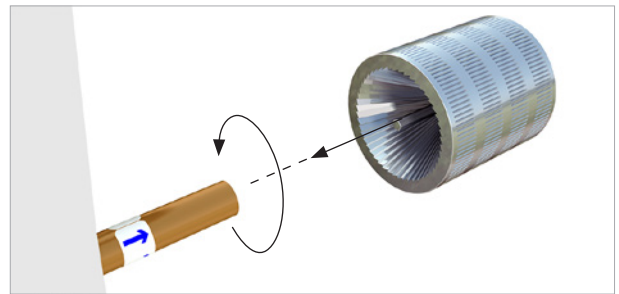
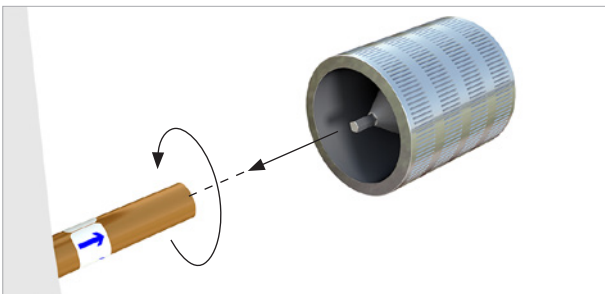
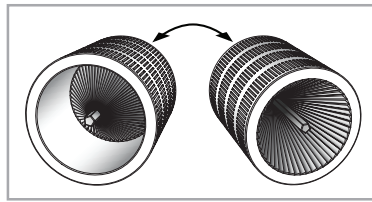
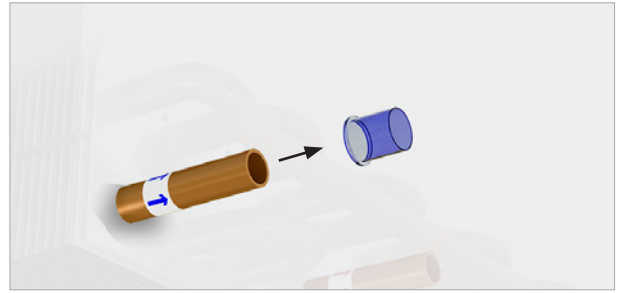

Flexible hoses and Push-on valves

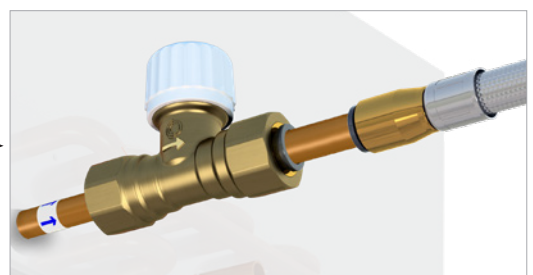
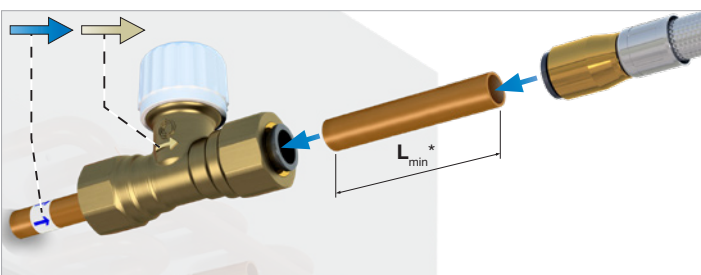
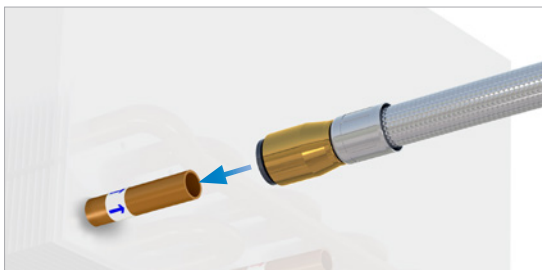

* $L_{min} = 70 \text{ mm}$ (to ensure you can open the couplings again).
 Lindab flexible hoses are available with straight end (male) for direct connection to Lindab valves also.

Quick installations guide

Professor XP

Preparation for installation on the product

The beam is prepared for installation by threaded rods M8.

4 x M8 per beam when $L_{nom} \leq 2700$ mm

6 x M8 per beam when $L_{nom} > 2700$ mm.



Threaded rod attachment points, non-flange models:

F-45, F-60, I-45, I-60

I-62, Y-60, Z-60 (ceiling adapted models)

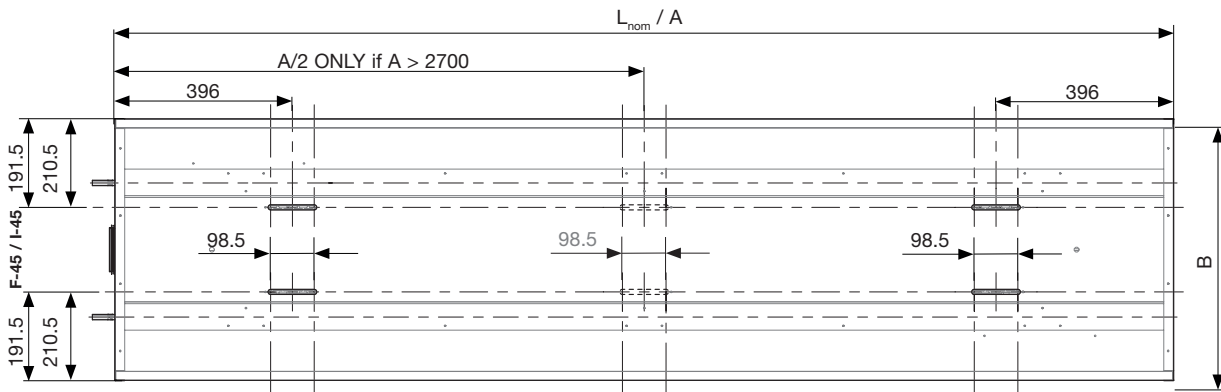

Threaded rod attachment points, flange models:

J-62, K-60, L-60, X-60 (ceiling adapted models)

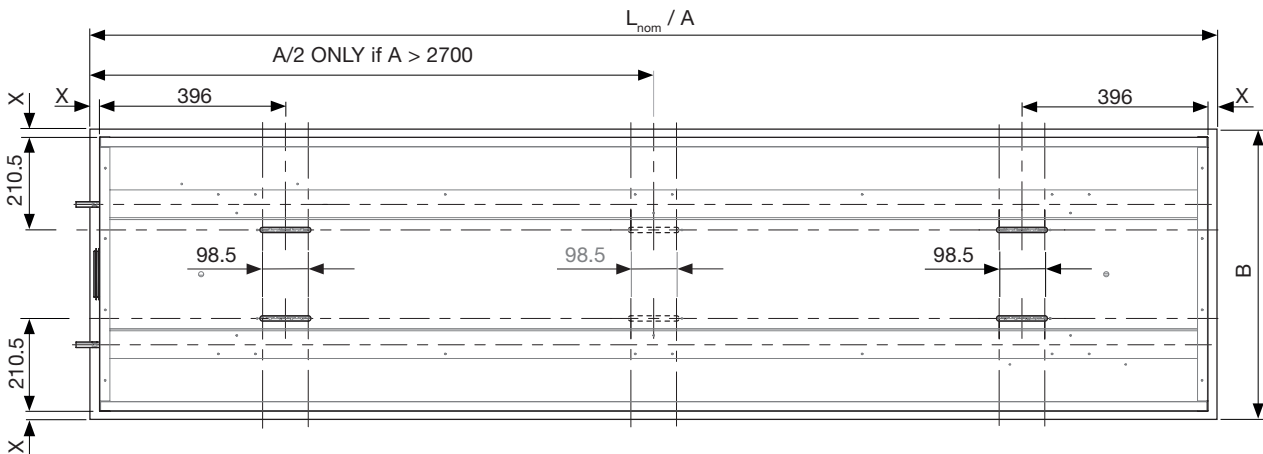

Professor XP	L_{nom}^* [mm]	A [mm]	B [mm]	X** [mm]	spec. weight [Kg / m]	Ceiling type
I-62	1200, 1800, 2400, 3000, 3600	1242, 1867, 2492, 3117, 3742	617	-	Go to page 5 see tables.	21
J-60		1192, 1792, 2392, 2992, 3592	592	22		8
K-60		1199, 1799, 2399, 2999, 3599	599	25.5		5
L-60		1224, 1824, 2424, 3024, 3624	624	16		3
X-60		1199, 1799, 2399, 2999, 3599	599	25.5		4, 6, 7, 14
Y-60		1175, 1775, 2375, 2975, 3575	575	-		9, 11
Z-60		1184, 1784, 2384, 2984, 3584	584	-		10

* L_{nom} = Nominal length (Order length).

** X = Flange dimension. - = no flange

Quick installations guide

Professor XP

Installation

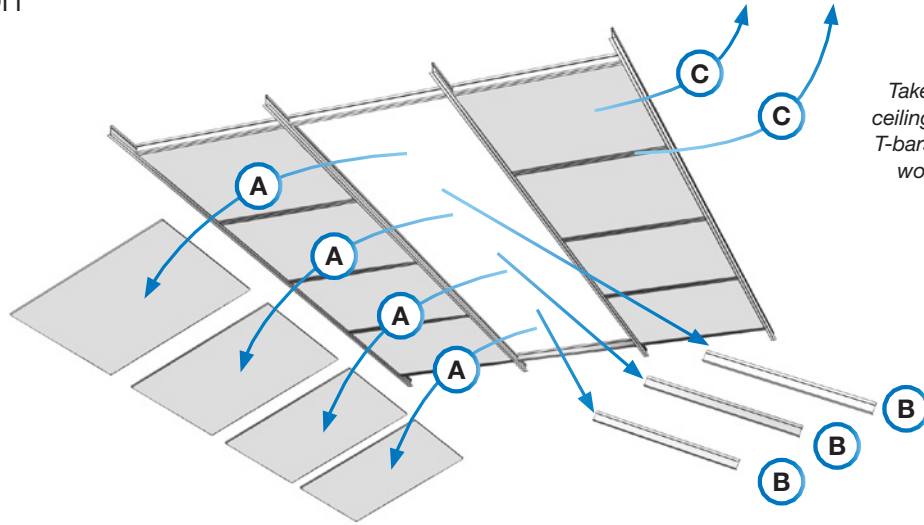

Take out extra ceiling plates and T-bars for proper work space.

(D)
To find correct alignment points for threaded rod hangers, see dimension drawings and table on previous page, covering all Professor XP models.

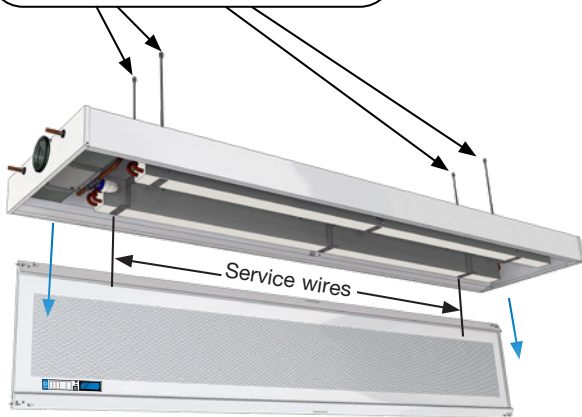
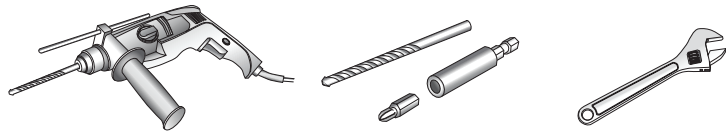

Lindab recommends removing faceplate completely before installation in ceiling. Go to page 14 Maintenance (F-models), and page 15 (other models). See "Open inlet faceplate"

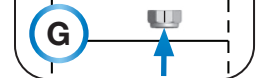
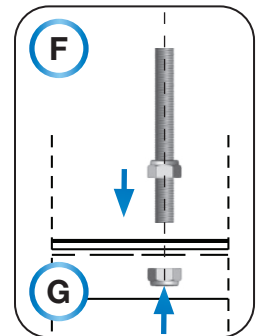
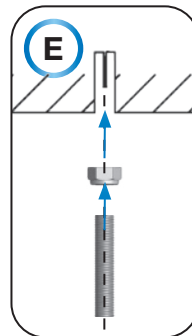

Heavy load !
Longest Professor XP models are 3.6 meters with a weight at aprox. 52 kg. Use professional lifting equipment.

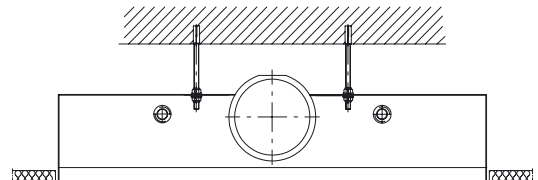
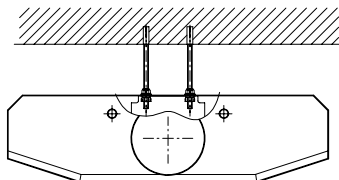
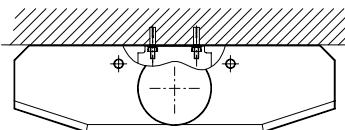
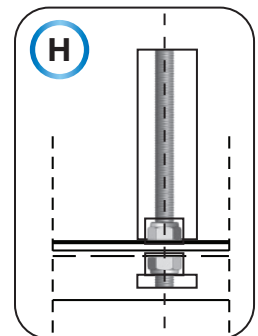

Quick installations guide

Professor XP

Measuring static nozzle pressure and air pressure

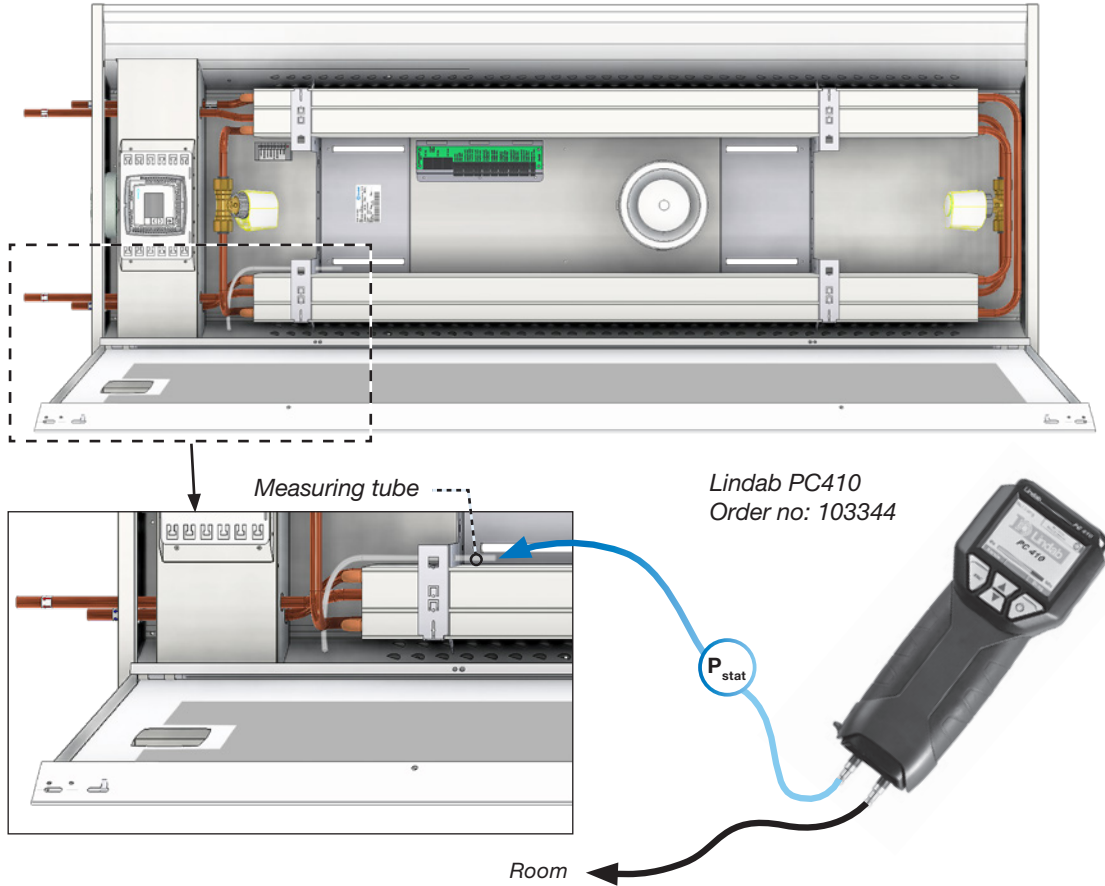

Example using diagram 1

Professor XP: PRO-I-60-12-1x100-A1-1200-2.4-60-35

$\Delta p_{stat} = 60 \text{ Pa}$ (static pressure loss) $n_{open} = 217 \text{ pcs.}$ $\Rightarrow q_a = 35 \text{ l/s}$ primary airflow rate

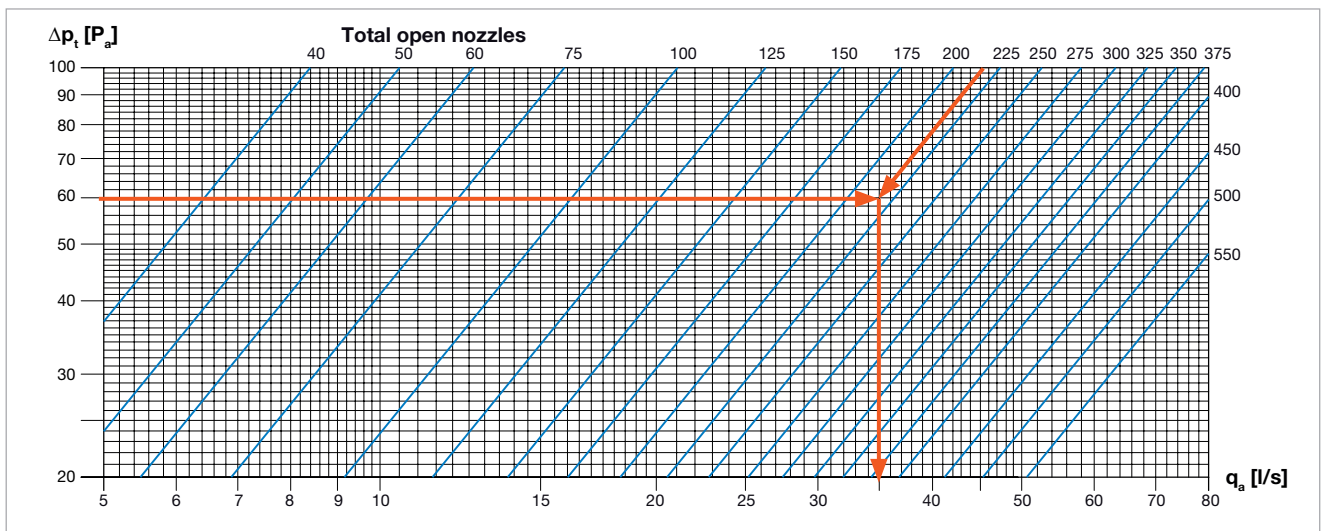

Quick installations guide

Professor XP

Maintenance F-models

Open inlet faceplate

F-45 / F-60

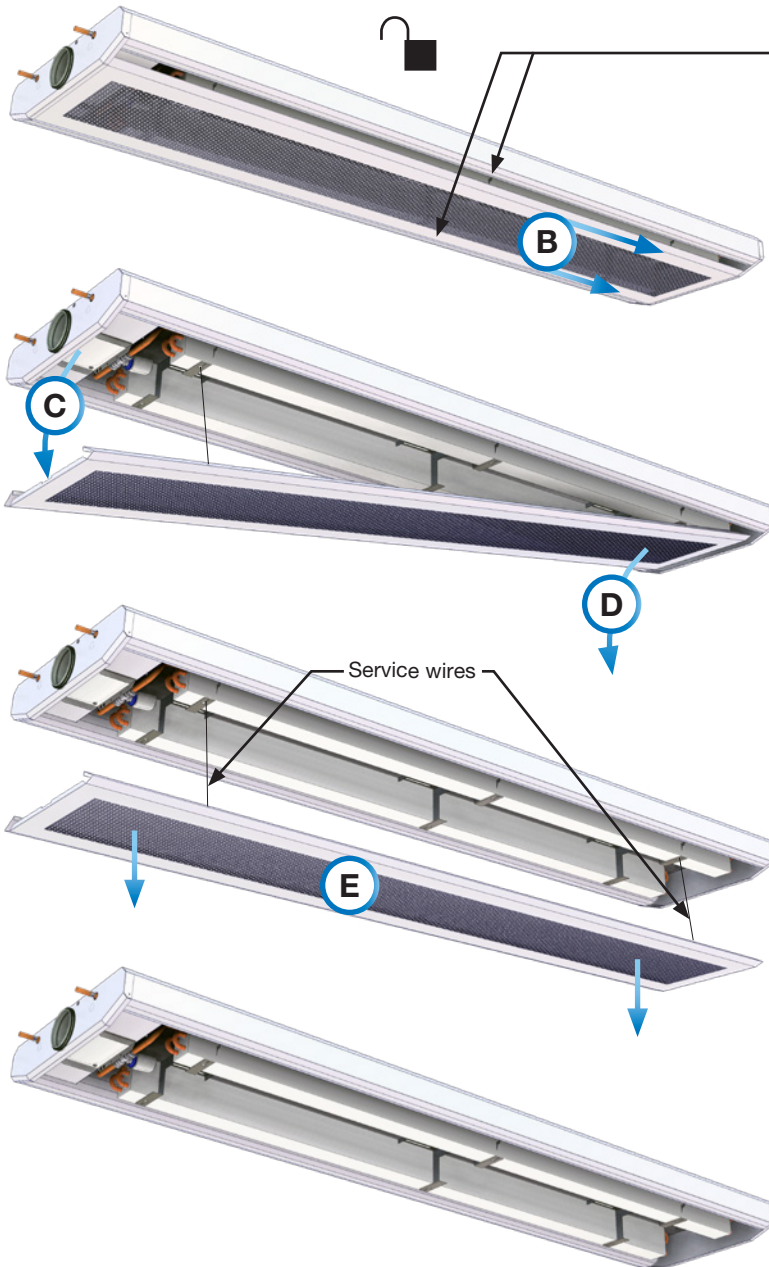

A

Face plate support bracket x2
2 pcs on each beam when $L_{nom} > 2.7$ m

The faceplate now hangs in service wire, it can be removed completely when demounted from service wire.

Reverse the shown steps
(E - A)
to reinstall faceplate

Quick installations guide

Professor XP

Maintenance other models

I-45 / I-60 .

Also valid for all ceiling adapted models I-62, J-60, K-60, L-60, X-60, Y-60 and Z-60.

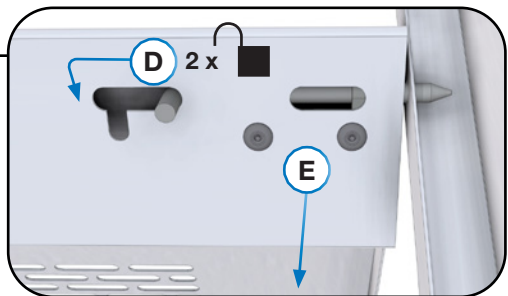
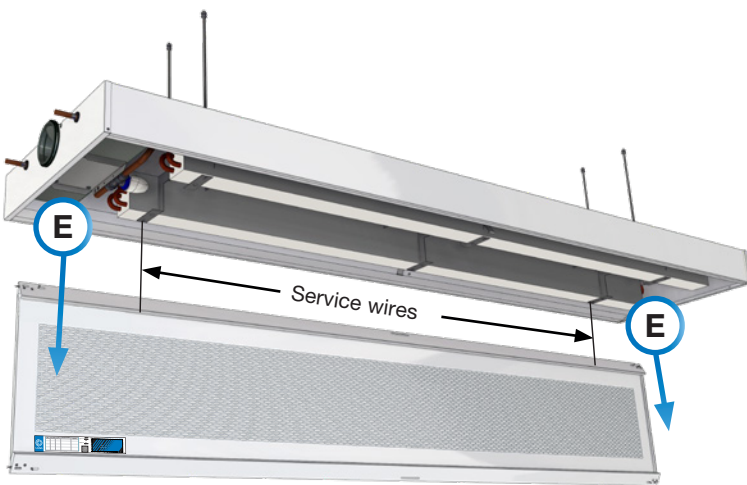
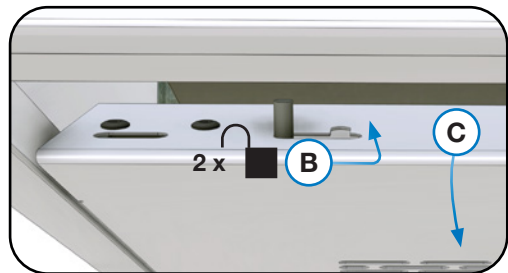
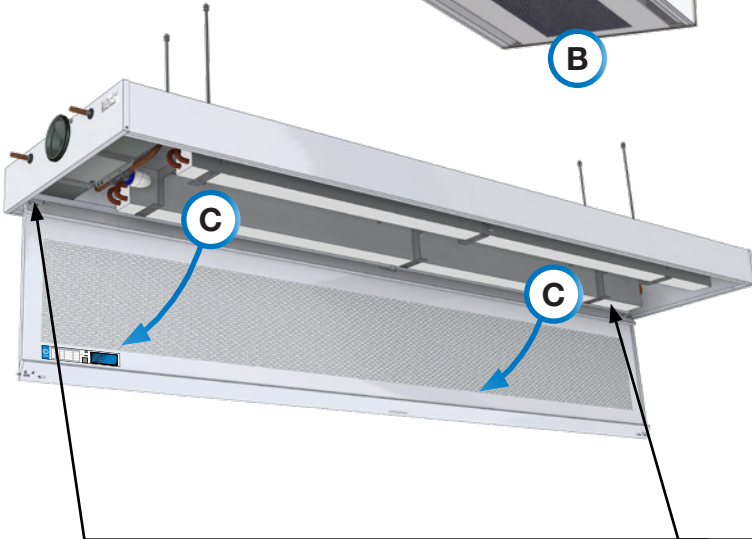
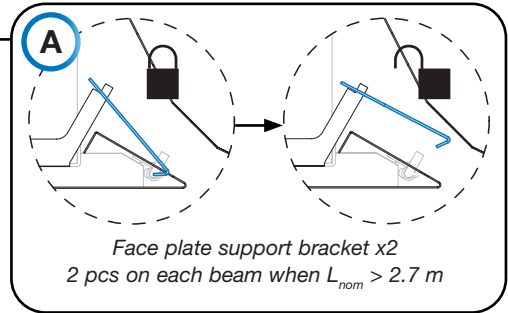
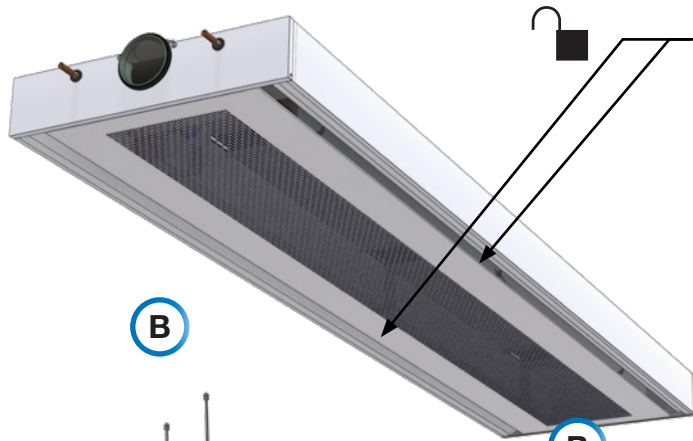

The faceplate now hangs in service wire, it can be removed completely when demounted from service wire.

Reverse the shown steps (E - A) to reinstall faceplate



Most of us spend the majority of our time indoors. Indoor climate is crucial to how we feel, how productive we are and if we stay healthy.

We at Lindab have therefore made it our most important objective to contribute to an indoor climate that improves people's lives. We do this by developing energy-efficient ventilation solutions and durable building products. We also aim to contribute to a better climate for our planet by working in a way that is sustainable for both people and the environment.

[Lindab](#) | For a better climate